



Fire Alarm Control Panel (Linkage Type)

Model No.: ATL-MN300



Angel Technologies Hongkong Ltd.

Address: 3/F, Chuangsheng Building(South), Sunshine Industry Area, Xili Town, Nanshan District, Shenzhen, China

Tel: +86 0755 2981 0450

Fax: +86 0755 23707411

<http://www.atlfire.hk>

Contents

I. General description.....	1
II. Operation instructions	2
III. External dimensions and installation dimensions	20
IV. Wiring diagram	22
V. Main technical parameters	23
VI. Precautions	24

I. General description

The ATL-MN300 is a new type of analog fire alarm control panel which has 324 alarm control points (detectors and modules which are characterized by fully mixed coding, non-polarity and two buses). It complies with the provisions of both Fire Alarm Control Units (GB4717-2005) and Automatic Control System for Fire Protection (GB16806-2006).

Its characteristics are as follows:

- The intelligent detectors and the intelligent modules have internal microprocessors to realize digital filtering and auto-compensation functions; the data collection is true and reliable; the ATL-MN300 control panel can carry out data processing based on fuzzy control theory and modern fire alarm theory to fundamentally avoid missing alarms and to reduce false alarms, so as to improve reliability.
- The detectors have a sensitivity setup function and can adjust the alarm sensitivity according to the specific environment and their influences.
- The detecting bus and the control bus share a two-wire structure and have non-polarity and fully mixed coding of the detectors and modules, and the intelligent detectors and the intelligent modules can be directly connected to them, which greatly simplifies the system wiring, engineering installation and circuit maintenance.
- The system uses an AC-DC master-standby power supply system which will automatically change between the master and standby power supplies in the event of a power failure of either of the two power supplies to ensure uninterrupted operation of the system.
- The ATL-MN300 can be connected to a special mini-printer to realize real-time printing.
- The ATL-MN300 can be connected to floor fire display panels to display fire alarms by standard RS-485
- The ATL-MN300 can be connected to ten multi-line linkage control/monitoring points to control and monitor important equipment.
- The ATL-MN300 is equipped with eight bus manual control points, which makes it very easy for the user to control related equipment.

This User's Manual introduces the system's user interface, keyboard operation and function set-up. It describes these with pictures and text to make it easy for the user to master usage quickly. Other sections introduce the system structure, wiring method, technical characteristics and precautions for the ATL-MN300 (**please pay more attention to the descriptions in Precautions**) for the user's reference.

II. Operation instructions

§1 Access to the system

§1-1 Non-password protection operations and password protection operations

The fire alarm control panel can realize both password protection operations and non-password protection operations.

In the non-password protection operation mode, the user can access the following operations without the necessity of inputting a password.

- Press the numeric key 0 to display the version information;
- PANEL MUTE MUTE/NORMAL;
- KEYBOARD START/STOP;
- Display current fire alarm;
- Display faults;
- Display startup/feedback.

Those operations which can only be done after a password is inputted by the user are password protection operations, including:

- System setup;
- Alarm setup;
- Clear setup;
- Manual control setup;
- History Record;
- Password setup;
- Self-checking;
- Reset;
- MANUAL CONTROL PERMIT/FORBID;
- GENERAL LINKAGE PERMIT/FORBID;
- SOUNDER LINKAGE PERMIT/FORBID;
- SOUNDER CONTROL MUTE/NORMAL.

Note: When the BUS MANUAL CONTROL ENABLE indicator is lit, the bus manual control panel is not under password protection and can be operated.

When the system is running and the KEYBOARD key is pressed, "Input password" will display on the LCD. After the correct password is inputted and the # key is pressed, the system will return to the main interface and the KEY ON/OFF indicator will be lit, which shows that the keyboard is unlocked. After that, the user can press the numeric key 1 to enter the system for system setup and query operations. There are three chances for password inputting. Pay attention to the KEY ON/OFF indicator: Keyboard operations can be done only when the indicator is on; if the indicator is off, it shows that the keyboard has been locked and it is necessary to input a password again before keyboard operations. If there are no keyboard operations within 3 minutes, the keyboard will be closed automatically and the KEY ON/OFF indicator will go out.

Factory defaults for the password:

- Supervisor password: 888888
- Administrator password: 666666
- Attendant password: 000000

§1-2 Confirming and canceling an operation

After an operation is completed, press the # key to save the data change or the * key to cancel the operation and have the data remain unchanged. If the system is restarted following a power failure before the data change is saved, the unsaved data will be lost. It is therefore recommended to form the habit of pressing the # key frequently to save data during system setup.

Note: The system is provided with an attendant password, an administrator password and a supervisor password. The attendant can only view the set data; the administrator can operate every function when there is no fire alarm; and the supervisor can set every function in any circumstance. When the user tries to operate the functions beyond his or her authority limit, the system data will remain unchanged. Hence the user should input the right password during system setup.

§1-3 Timeout-cancel function

If the user does not press the # key for timely data saving and has not pressed any keys within three minutes when operating the system, the system will automatically cancel the entire operation, return to the main interface and lock the keyboard. In this case, the unsaved operations will be “forgotten”. Hence the user should have a good plan before setting the system, so as to avoid the necessity of thinking while setting the system and to improve the reliability and efficiency of system setup.

§1-4 Configuration data input function

When the user is doing a system setup, a lot of data needs to be inputted. In order to improve the efficiency of system setup, the user can use the ▲ and ▼ keys to input non-numeric data or use the numeric keys from 0 to 9 on the keyboard to type in numbers; when describing the position of a detector or module, the user can select four types of input methods including Digital Input, Lowercase Input, Uppercase Input or Chinese Character Location Input.

§1-5 Unlocking the keyboard and entering the main menu

To set the system and other equipment, the first thing to do is to unlock the panel keyboard by pressing the **PANEL KEYBOARD** key, input the correct password and finally press the # key. If the KEY ON/OFF indicator is on, it shows that the panel keyboard has been unlocked. After that, press 1 to enter the main menu of the setup function as follows.

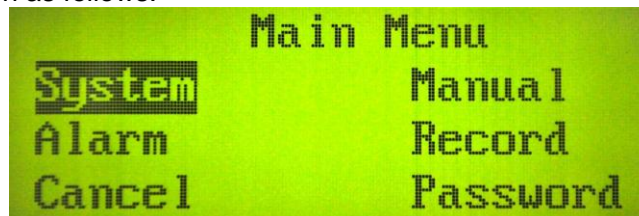

Press▲ ▼ ◀ or ▶to move the cursor to the wanted function, and then press the # key to enter or the * key to go back. If no selection is done within ten minutes, the system will exit the main menu, return to the main interface and lock the panel keyboard.

§1-6 Locking the keyboard

There are two ways to lock the keyboard: First, return to the main interface and press the **KEYBOARD** key; and second, if there are no key operations within ten minutes, the system will automatically return to the main interface and lock the keyboard. After the keyboard is locked, the KEY ON/OFF indicator will go out.

§2 Configuration of the master control board

This chapter introduces the detailed configuration process of the master control board.

§2-1 Accessing to the system

To set the system and equipment, the user may press the **KEYBOARD** key, input the correct password and press the # key to unlock the keyboard and then press 1 to access the system when the keyboard is locked, or directly press 1 to access to the system when the keyboard is unlocked (namely when the **KEY ON/OFF** indicator is on). Below is the interface of the main menu for the system.



Press ▲ ▼ ◀ or ▶ to move the cursor to the wanted function, and then press the # key to enter or the * key to go back. If no selection is made within three minutes, the system will exit the main menu, return to the main interface and lock the panel keyboard.

§2-2 System setup

Enter the **System** interface, and the following content will be seen.



Press ▲ or ▼ to move the cursor, press the # key to set the option where the cursor is and the * key to go back. For example, if the cursor is now at the Time Setup option, pressing the # key can change the current time.

§2-2-1 Time setup

Select **Time setup** in the menu, and the interface will display the following content.



What is displayed in the top right corner is the current time. Press ◀ ▶ to move the cursor to the option to be changed, input the wanted figure and press the # key to confirm the change or the * key to cancel the change and maintain the current time.

§2-2-2 Repeater panel setup

Select **Repeater panel setup** in the menu, and the interface will display the following content.



Select No., Register, Zone, Floor, Type or Indicate by pressing ◀ ▶. Type and Indicate are two constant options. At present, only ATL-982 Chinese display panels are equipped with the system for use by the user.

When the cursor is at the Display option, the user can change the display mode by pressing ▲ or ▼.

- By Zone: Display all the alarm information for the entire zone.
- By Floor: Display the fire alarm information of the floor or the floors close to it.

Note: According to the requirements of relevant national standards, when the “By Floor” mode is set for the display panels and the Floor No. is 1, all the fire alarms from the basements will be displayed.

The system can be connected to 30 display panels at most. If there are lots of display panels or the connecting lines are long, it is suggested to use thicker twisted-pairs when possible. For usage at a place with strong interference, it is suggested to use shielded twisted pairs (STPs) and welding technology for the joints when possible. The detailed wire diameter depends on the construction

environment. If there are only a few display panels and the connecting lines are short, then ordinary joining techniques may be used.

§2-2-3 Printer setup

Select Printer Setup in the menu, and the interface will display the following content.



Input 1 to make the printer registered and to enable its printing function; or input 0 to make the printer unregistered and to disable its printing function. Set according to the actual need and press the # key to save the setup or the * key to go back.

§2-3 Alarm setup

Set Alarm setup in the main menu and press the # key to enter the interface with the following content.



When the cursor is at **Loop setup**, the user may press the # key to set the detectors and the modules. The User may press ▲ ▼ ◀ or ▶ to move the cursor to select the option and then press the # key to set the selected option or the * key to back.

Note: The system linkage setup and other setups will be set by zone, floor or room, so all the data must be carefully recorded.

§2-3-1 Loop setup

Select Loop setup in the menu, and the interface will display the following content.

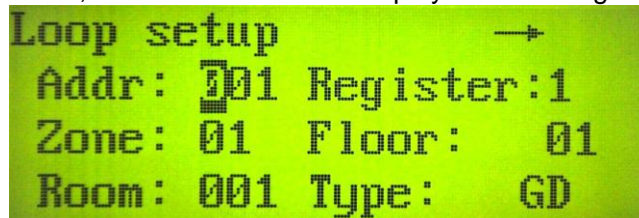

The “→” sign in the top right corner means that there is a page following the current page. After this interface is set, the user may press the ▶ key to enter the next interface as follows:

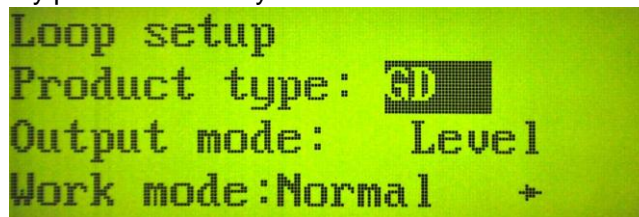

The “←” sign in the top left corner means that there is a page before the current page and the system may go back to the previous menu after the ◀ key is pressed. After this interface is set, the user may press the ▶ key to enter the next interface as follows:

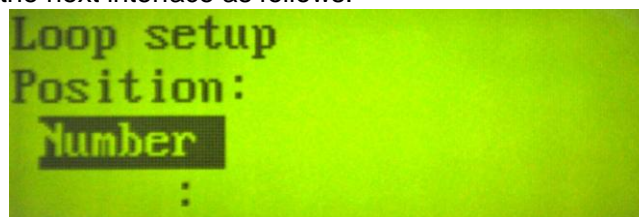

Description of the setting items of the three interfaces above:

Address: This includes the addresses of the detectors, the modules, the horn/strobe and other equipment, ranging from 001 to 324. The User may set the parameters of a piece of equipment by inputting its address number through the numeric keys or obtain it through auto login.

Register: This refers to the operating conditions of the equipment with its address: When it is 1, it means that the equipment has been accessed to the system and can operate normally; and when it is 0, it means that the equipment has not yet been accessed to the system, or that the equipment has been accessed to the system but is shielded (the detectors give no alarms, or the modules fail to input, output, etc.). During auto login, the Register option will be set as 1 automatically. The User may set this option manually by pressing the numeric keys 1 or 0.

Zone : The system may be set with zones from 01 to 15 through the numeric keys.

Floor : The system may be set with 98 floors ranging from -9 to 89. Press the numeric key 9 to input “-” in front of floor numbers 1 to 9.

Room : The system may be set with 255 room numbers ranging from 001 to 255 through the numeric keys.

Type: This refers to the types of equipment. They may be identified through auto login. The types of equipment that may be identified through auto login include:

- Ion detector and photoelectric detector;
- Heat detector (constant temperature);
- Heat detector (rate-of-rise and fixed temperature);
- Combined detector (photoelectric and constant temperature);
- Combined detector (photoelectric and rate-of-rise and fixed temperature);

- Input module (interface);
- Input module (monitoring);
- Output module (control);
- I/O module (control and monitoring);
- Multi-input model (interface);
- Multi-input model (monitoring);
- Multi-output module (control);
- Multi-I/O module (control and monitoring);

- Manual call point;
- Hydrant call point;

- Horn
- Beacon
- Horn/strobe

User may also set manually through ▲ and ▼. The following types are available for selection by user.

- Horn/Strobe
- Back
- Sounder
- Broadcast
- Air-conditioner
- Roll door
- Elevator
- City power exchange
- Fire water electromotor
- Sprinkler electromotor
- Generator
- Sprinkler valve
- Fireproof door
- Fireproof valve
- Air in valve

-
- Air in fan
 - Air valve
 - Air out fan
 - Air out valve
 - Valve
 - Electromagnetic Valve
 - Agent
 - Water flow displayer
 - Hydrant
 - Pressure
 - Temperature sensing cable
 - Manual call point
 - IO module
 - Combined
 - Infrared
 - Heat
 - Photoelectric
 - Ion

Note: The types of equipment is shortening in display, please see attached list 1 for their corresponding relationship.

Production type: This refers to the production types of detectors. The user may set these through auto login or manually through ▲ and ▼. The following types are available for selection by the user.

- Hydrant call point
- Manual call point
- Combined detector
- Heat detector
- Photoelectric smoke detector
- Ion detector
- Beacon
- Horn
- Horn/Strobe
- Fireman control module
- Bus manual control module
- Monitor and control module
- Control module
- Monitor module
- I/O Module

Note: The types of production is shortening in display, please see attached list 2 for their corresponding relationship.

Output mode: This refers to the output mode of the control module during a linkage output. It may be selected through ▲ and ▼. The following output models are available for selection by the user.

- Constant output: This means a module keeps outputting after it starts to operate until the control panel is reset or gives a stop instruction.
- Pulse output: This means a module automatically stops outputting in 6 seconds later after it starts to operate.

Operating mode: This is used for setting the sensitivity of a detector through ▲ and ▼. There are three sensitivities available as follows for selection by the user.

- Medium sensitivity
- Low sensitivity
- High sensitivity

Position: This is the description of the specific position of a piece of equipment. It may be used for describing the specific positions of various equipment addresses. At most 7 Chinese characters or 14 letters may be inputted.

When the cursor is at the Input Method Select option, the user may use ▲ and ▼ to select between the following four input methods.

- Digital Input
- Lowercase Input
- Uppercase Input
- Chinese Character Location Input

When a Chinese character is inputted, the cursor should be moved to the front of ':' on the next line under the input method.

Digital Input: In this input method, press the relevant numeric keys directly to input the wanted figure or use ▼ to delete any wrongly inputted figures.

Lowercase Input: In this input method, the numeric key 2 stands for abc, 3 for def, 4 for ghi, 5 for jkl, 6 for mno, 7 for pqrs, 8 for tuv, 9 for wxyz; when a numeric key is pressed, the corresponding letters will be listed from left to right in a sequence of 1, 2, 3 and 4. For example, to input letters akz, just press the numeric key 2 to display abc and 1 to input the letter a, then press the numeric key 5 to display jkl and 2 to input the letter k, and finally press the numeric key 9 to display wxyz and 4 to input the letter z. If the user moves the cursor to the figure in front of ":" and presses other numeric keys, the current figure will be covered, the newly inputted figure will be displayed and other letters may be inputted at this time. The User may also move the cursor to a letter to be selected and then press ▲ to input the letter. Press ▼ to delete the wrongly inputted content.

Uppercase Input: The operation method is the same as that of the Lowercase Input.

Chinese Character Location Input: In this input method, the user can input a Chinese character by pressing four numerical keys only. The User can move the cursor to the input digit and press another numerical key to replace it. Under the text input mode, the user can press the ▼ key to delete the wrongly inputted words. (It is the same as that in the following module setup) Finally press # key to save the settings.

Note: After an address is set, press the # key to save the settings, otherwise the changed data will be ignored.

§2-3-2 Auto login

Move the cursor to **Auto login** and then press the # key for login.



After login, the interface will display the following content.

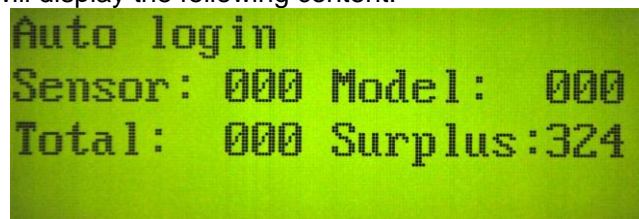

After login, there are 99 sensors, 29 modules and 196 surplus addresses. Press the # key to save the data. If the # key is not pressed at this time, a Login Completed interface will pop up periodically to remind user to save the data.

§2-3-3 Linkage setup

Move the cursor to **Linkage setup** and then press the # key. After that, the interface will display the following content.

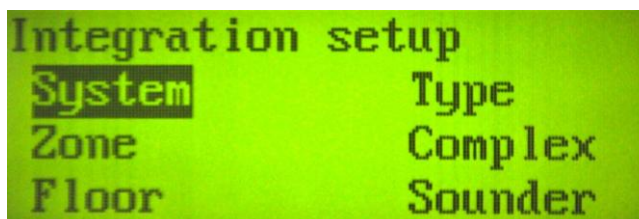

1) The User may set the **System integration** option by moving the cursor to the **System** option and pressing the # key. The following content will be displayed.



```
System integration
GroupNo: 01 Register: 0
Deley: 000S Address: 000
```

The system integration is a kind of linkage in which a piece of monitoring equipment in the entire system (including Ion, Photoelectric, Heat, Infrared, Complex, Interface, Manual Alarm, temperature sensing cable, Pressure, Hydrant, flow detector and so on) may trigger module actions.

No.: This refers to the linkage number. There are 30 groups ranging from 01 to 30. Through this option, the user can view, set or modify the linkage of the groups.

Register: Register =1, valid; Register =0, invalid.

Delay: This refers to the time delay after the control panel receives an alarm signal and before it makes the module with the corresponding address act. The User can select among "000S", "005S", "010S", "030S", "060S", "090S", "120S" and "150S" through▲and▼.

Address: This refers to the address of the module needed to be started by the system after an alarm is given.

Note: After the setup is finished, press the # key to save, or the * key to go back to the previous menu.

2) The User may move the cursor to the **Zone** option and press the # key for setting. The following content will be displayed.



```
Zone integration
Group No: 01
Zone No: 5 Register:
Delay: 150S Address: 35
```

The zone integration is a kind of linkage in which a piece of monitoring equipment in a zone (including Ion, Photoelectric, Heat, Infrared, Complex, Interface, Manual Alarm, temperature sensing cable, Pressure, Hydrant, flow detector and so on) may trigger module actions.

Group No.: This refers to the linkage number. There are 30 groups ranging from 01 to 30. Through this option, the user can view, set or modify the linkage of the groups.

Zone No.: There are 15 groups of zone numbers from 01 to 15.

Register: Register =1, valid; Register =0, invalid.

Delay: This refers to the time delay after the control panel receives an alarm signal and before it makes the module with the corresponding address act. The User can select among "000S", "005S", "010S", "030S", "060S", "090S", "120S" and "150S" through▲ and ▼.

Address: This refers to the address of the module needed to be started by the system after an alarm is given.

Note: After the setup is finished, press the # key to save, or the * key to go back to the previous menu.

3) The User may move the cursor to the **Floor integration** option and press the # key for setting. The following content will be displayed.



```
Floor integration
Type: 0000
Register:
Updown floor:
```

The floor alarm integration is a kind of linkage in which a piece of monitoring equipment on a floor (including Ion, Photoelectric, Heat, Infrared, Complex, Interface, Manual Alarm, temperature sensing cable, Pressure, Hydrant, flow detector and so on) may trigger the module actions of the floor or the floors close to it.

Type: This is used for setting the type of the acting module of the floor through ▲ and ▼. The linkage types include:

- Broadcast
- Air-conditioner
- Roll door
- Elevator
- Water flow displayer
- Fire water electromotor
- Sprinkler electromotor
- Generator
- Sprinkler valve
- Fireproof door
- Fireproof valve
- Air in valve
- Air in fan
- Air Valve
- Air out fan
- Air out Valve
- Valve
- Electromagnetic valve
- Agent

Register =1, valid; Register =0, invalid.

Updown floor: This means that neighboring floors act at the same time. "0" means that cross-floor does not exist; and "1" means that cross-floor exists.

Note: After the setup is finished, press the # key to save the settings and to set the next group, or press the * key to go back to the previous menu.

4) The User may move the cursor to the **Type** option and press the # key for setting. The following content will be displayed.



```
Type alarm integration
Group No: 01 Register:
Type:          Start: 35
Delay: 150S
```

Type alarm integration refers to a kind of linkage in which a detector or module in the entire system triggers the actions of another module when giving an alarm or making feedback.

Group No. This refers to the linkage number. There are 30 groups ranging from 01 to 30. Through this option, the user can view, set or modify the linkage of the groups.

Register =1, valid; Register =0, invalid.

Type: This is used for setting the type of the equipment triggering the linkage through ▲ and ▼.

- Horn/Strobe
- Back
- Sounder
- Broadcast
- Air-conditioner
- Roll door
- Elevator
- City power exchange
- Fire water electromotor
- Sprinkler electromotor
- Generator
- Sprinkler Valve
- Fireproof door
- Fireproof valve
- Air in valve
- Air in fan
- Air valve

-
- Air out fan
 - Air out Valve
 - Valve

- Electromagnetic Valve
- Agent
- Water flow displayer
- Hydrant
- Pressure
- Temperature sensing cable
- Manual call point
- I/O module
- Combined
- Infrared
- Heat
- Photoelectric
- Ion

Start: This refers to the address of the module needed to be started after the system gives an alarm.

Delay: This refers to the time delay after the control panel receives an alarm signal and before it makes the module with the corresponding address act. The User can select among “000S”, “005S”, “010S”, “030S”, “060S”, “090S”, “120S” and “150S” through ▲ and ▼.

Note: After the setup is finished, press the # key to save the settings and to set the next group, or press the * key to go back to the previous menu.

5) The user may move the cursor to the **Complex** option and press the # key for setting. The following content will be displayed.

```
Complex integration
Group No: 01 Register:
Addr1: 35 Addr2: 35
Delay: 150S Start: 35
```

Complex integration is a kind of linkage in which the simultaneous alarming or feedback of two detectors or modules in the system triggers module actions.

Group No.: This refers to the linkage number. There are 30 groups ranging from 01 to 30. Through this option, the user can view, set or modify the linkage of the groups.

Register =1, valid; Register =0, invalid.

Addr 1: This refers to the address of a alarm detector or alarm (feedback) module triggering the module actions.

Addr 2: This refers to the address of a alarm detector or alarm (feedback) module triggering the module actions.

Delay: This refers to the time delay after the control panel receives an alarm signal and before it makes the module with the corresponding address act. The user can select among “000S”, “005S”, “010S”, “030S”, “060S”, “090S”, “120S” and “150S” through ▲ and ▼.

Start: This refers to the address of the module needed to be started after the system gives an alarm. When the two pieces of equipment corresponding to address 1 and address 2 give an alarm or make feedback at the same time, module actions will occur after the set time delay is reached.

Note: After the setup is finished, press the # key to save the settings and to set the next group, or press the * key to go back to the previous menu.

6) The user may move the cursor to the **Sounder** option and press the # key for setting. The following content will be displayed.

```
Sounder integration
Type: 12 Register:
Updown: Start:sounder
```

Sounder integration is a kind of linkage in which a piece of monitoring equipment in a zone (including Ion, Photoelectric, Heat, Infrared, Complex, Interface, Manual Alarm, temperature sensing cable, Pressure, Hydrant, flow detector and so on) receives an alarm signal and starts the bell and the fire radio system of

the zone where the alarm equipment is or of the neighboring floors.

Register =1, valid; Register =0, invalid.

Cross-floor: This means that neighboring floors act at the same time. "0" means that cross-floor does not exist; and "1" means that cross-floor exists.

Start: Bell and horn/strobe

Note: After the setup is finished, press the # key to save the settings and to set the next group, or press the * key to go back to the previous menu.

Note: To make the linkage setup work, the Sounder Linkage and General Linkage on the panel must be set in the auto mode, i.e. the Sounder Linkage and General Linkage indicators must be on.

§2-3-4 Checking

Move the cursor to the **checking** option and then press the # key. After that, the following content will be displayed.

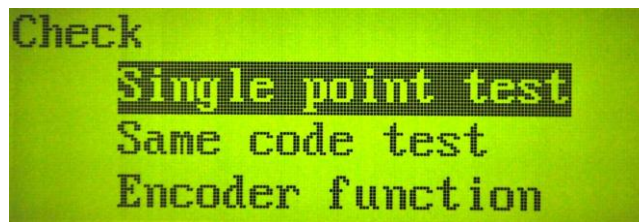

Single point test: This can be done to test a specific piece of equipment.

Move the cursor to the **Single point test** option and press the # key to start a single point test. The following content will be displayed.



§2-4 Cancel setup

Move the cursor to the **Cancel** option and press the # key. After that, the following content will be displayed.

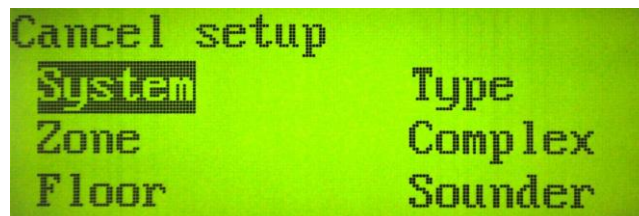

The cursor points out the setting item to be cleared. Press ▲ ▼ ◀ or ▶ to move the cursor to the wanted setting item easily, and then press the # key to clear the setting item. After that, there will be a screen refresh; it shows that the data has been deleted.

§2-5 Hand control key setup

Move the cursor to the **Manual** option and press the # key. After that, the following content will be displayed.

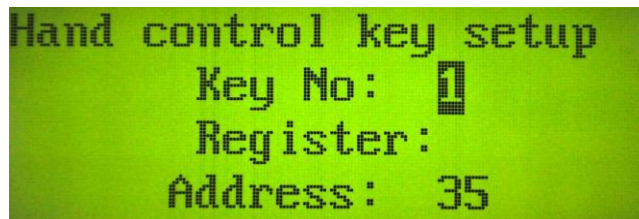

Key No.: The user may input key numbers 1~8 corresponding to the eight manual control buttons on the panel. The corresponding positions are shown in the figure below.

Register =1, valid; Register =0, invalid.

Address: This refers to the address of the module to be started.

The buttons on the bus manual control panel can work only when the Bus Manual Control Enabled/Disabled indicator is lit. When a key is pressed before it is set, the Request indicator will not be lit; and when a key is set and pressed in order, the Request indicator will be lit and send a control signal to the corresponding model. As long as there is feedback from the corresponding module when a key is set, the Answer indicator will be lit, no matter whether or not the Bus Manual Control Enabled/Disabled indicator is lit.

Note: After the setup is finished, press the # key to save, or the * key to go back to the previous menu.

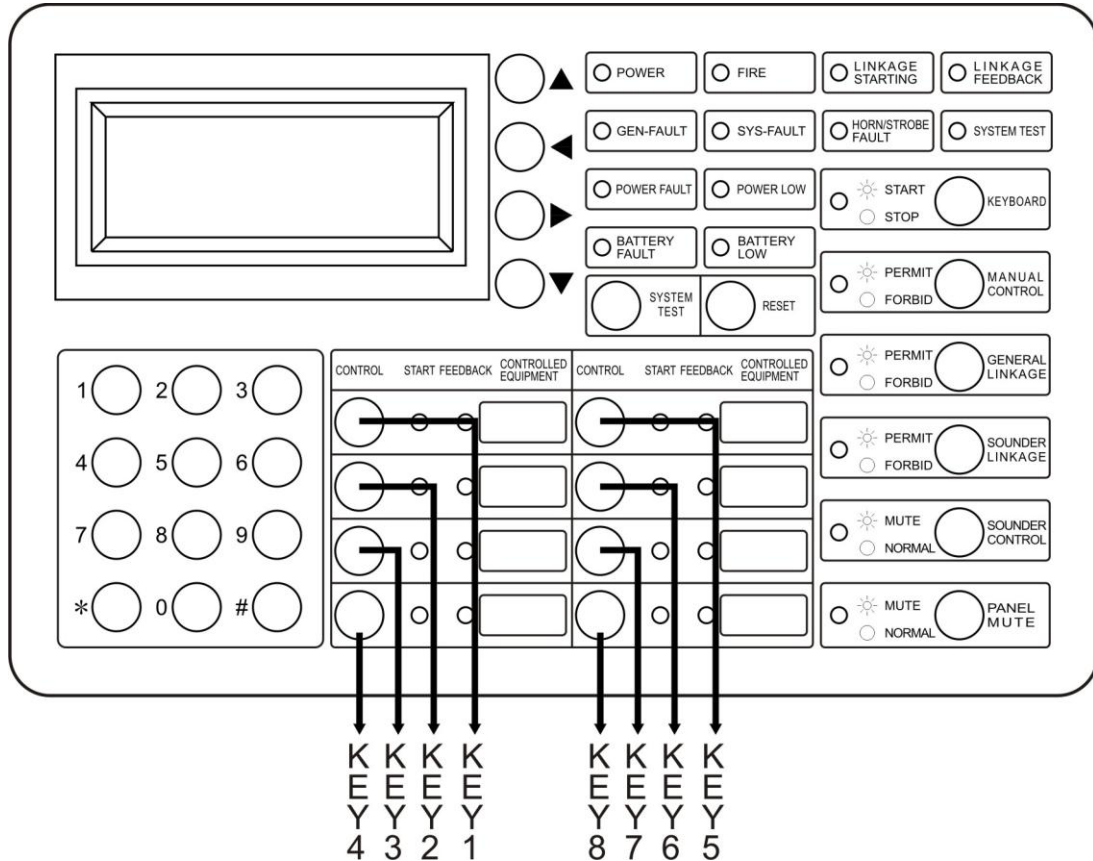

§2-6 History Record

Move the cursor to the **Record** option and press the # key. After that, the following content will be displayed.

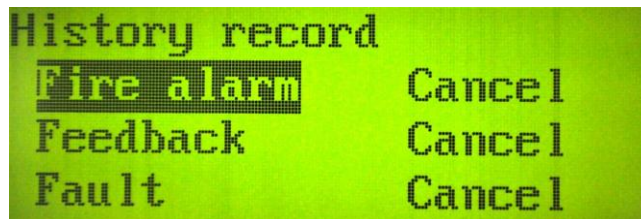

When the cursor is now at the **Fire alarm** option, the user may query the history of fire alarms by pressing the # key. The user may move the cursor through ▲ ▼ ◀ or ▶ and press the # key to query or delete the option where the cursor is. The system can record at most 999 pieces of information for each kind of history. When there is a new piece of information after there have been 999 pieces already, the earliest piece of information will be deleted automatically.

§2-7 Password setup

Move the cursor to the **Password** option and press the # key. After that, the following content will be displayed.



Press ▲ and ▼ to move the cursor to modify the settings of Highest level, Manager level and Guarder level.

- When logging in as a supervisor with highest level, the user can modify the settings for Supervisor Password, Administrator Password and Attendant Password;
- When logging in as an administrator with manager level, the user can modify the Administrator Password and Attendant Password; and
- When logging in as an attendant with guarder level, user can modify the setting of Attendant Password only.

Factory defaults of the password:

- Supervisor password: 888888
- Administrator password: 666666
- Attendant password: 000000

§2-7-1 Supervisor password setup

Move the cursor to the **Highest level** option and press the # key. After that, the following content will be displayed.



Input the old password, and then input the new password twice and finally press the # key to save the new setting.

§2-7-2 Administrator password setup

Move the cursor to the **manager level** option and press the # key. After that, the following content will be displayed.

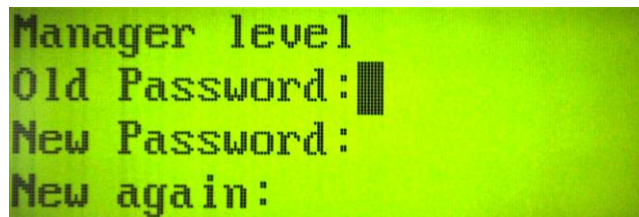

Input the old password, and then input the new password twice and finally press the # key to save the new setting.

§2-7-3 Attendant Password Setup

Move the cursor to the **guarder level** option and press the # key. After that, the following content will be displayed.



Input the old password, and then input the new password twice and finally press the # key to save the new setting.

§3 Display function

The system will display three interfaces, namely the fire alarm interface, the fault interface and the request/feedback interface. The fire alarm interface will display first. The User can use the ◀ and ▶ keys to switch between them for viewing.



The table above is the fire alarm interface. The words “Fire” are on the top left corner of the interface. “001/000” shows that there are no fire alarms in all and the cursor is at the No.1 fire alarm;



The table above is the request/feedback interface. “Start 00/ Back 00” means that there are two requests and two feedbacks; “00-01-10 02:00:59” is the system current time;

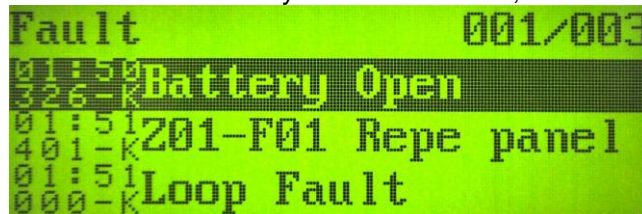

The table above is the fault interface. The word “Fault” is on the top left corner of the interface. “001/003” means that there are 3 faults in all and the cursor is now at the first fault; “01:50” is the fault occurrence time; “326” is the address No.; “-K” stands for open circuit fault; and “Battery Open” means that the battery disconnection.

The user can use the ▲ and ▼ keys to move the cursor to read every record. The first record will always display on the top, and the others will scroll. In the display interface, “-M” stands for missing, “-H” for fire alarm, “-K” for open circuit fault, “-D” for short circuit fault, and “-L” for type mismatch. Of all the address numbers, those from “001” to “324” are for the detectors and the modules; “000”, “327”, “325” and “326” are for circuit fault, printer fault, AC fault and DC fault respectively; and those from “328” to “357” are for fire display panel faults and correspond to fire display panels 01 to 30.

III. External dimensions and installation dimensions

External dimensions and installation dimensions (mm)

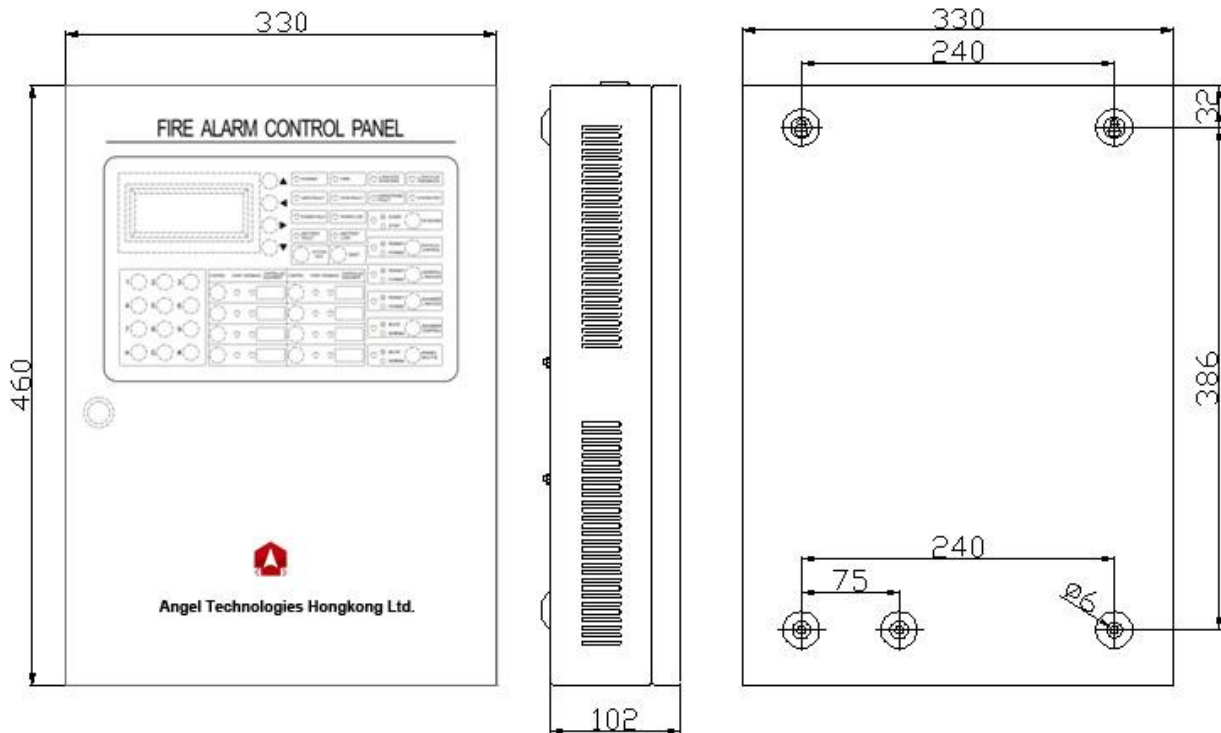
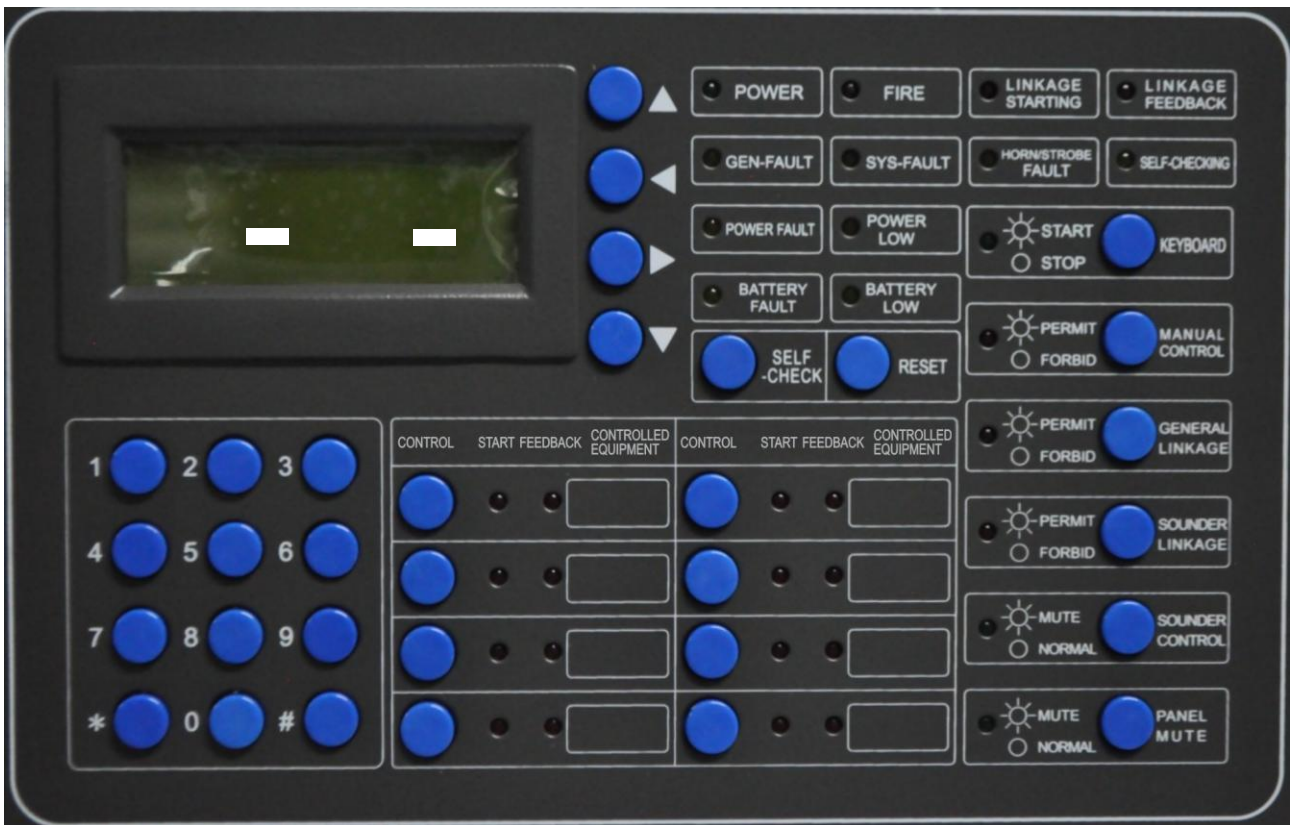

Diagram of case panel



-
- Instructions on keys and indicators:

1. Indicators:

POWER: The power supply of the control panel has been connected.

FIRE: The control panel has received a fire alarm.

LINKAGE STARTING: There is a linkage result output in the system.

LINKAGE FEEDBACK: The field equipment is active and there is a feedback signal.

GEN-FAULT: There is a fault in the system.

SYS-FAULT: When the system fails or crashes, this indicator will be lit.

HORN/STROBE FAULT: There is a piece of important fire equipment (such as bell, horn/strobe, etc.) that has failed.

SELF-CHECKING: When the system is entering the system test state, this indicator will be lit. Under this state, the system receives no alarm information.

POWER FAULT: When the AC power fails in the power supply, this indicator will be lit to report an AC fault.

POWER LOW: When the AC voltage is lower than 180V, this indicator will be lit to report an AC lack fault.

BATTERY FAULT: In case of an open circuit of the standby batteries, this indicator will be lit to report a DC fault.

BATTERY LACK: When the voltage of the standby batteries is lower than the working voltage, this indicator will be lit.

KEYBOARD: Only when this indicator is on, the key operations on the panel can be accepted by the main machine. And the PANEL MUTE key may be operated only when this indicator is off.

MANUAL CONTROL: Only when this indicator is on, the control keys of the bus manual control unit can work.

GENERAL LINKAGE: Only after this indicator is lit and the main machine receives a fire alarm, the set linkage can work.

SOUNDER LINKAGE: Only when this indicator is on, corresponding bell and the horn/strobe will act if there is a fire alarm.

SOUNDER CONTROL: If it is lit, it shows that the bell and the horn/strobe corresponding to the current fire alarm have been muted (stopped).

PANEL MUTE: If it is lit, it shows that the control panel (buzzer) has been muted (stopped).

2. Keys:

DIRECTION KEYS: Operating on the main machine and following the content displayed on the LCD to make the cursor move up, down, left and right.

KEYBOARD: Operate this to lock or unlock the panel keyboard.

GENERAL LINKAGE: Operate this to enable or disable the linkage output during a fire alarm.

SOUNDER LINKAGE: Operate this to enable or disable the bell or horn/strobe output during a fire alarm.

SOUNDER CONTROL: Operate this to stop or restart the bell or horn/strobe output during a fire alarm.

PANEL MUTE: Operate this to stop or restart the alarm output of the buzzer of the product.

Numeric keys 0 to 9: The user may create data setup for the product according to the prompts on the LCD and through the numeric keys 0 to 9.

BUS CONTROL: This is used for starting or stopping the output of corresponding control modules.

*: This is for canceling an operation.

#: This is for confirming and saving an operation.

Note: When a letter is input, the numeric key 2 stands for abc, 3 for def, 4 for ghi, 5 for jkl, 6 for mno, 7 for pqrs, 8 for tuv, and 9 for wxyz (it is the same as the letter layouts on cell phones and telephone sets).

IV. Wiring diagram

- System diagram

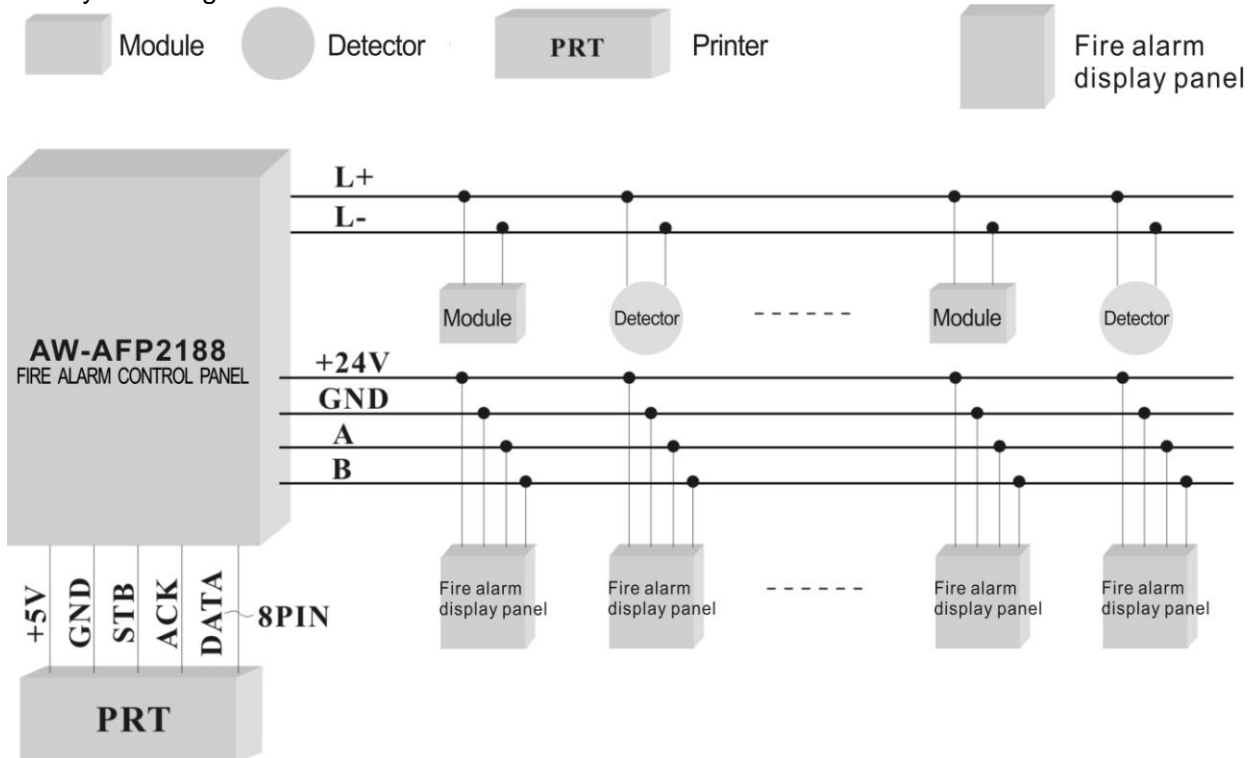

Note: See the wiring diagram of detectors and modules for the wiring of the detectors, the interface module, the monitoring module and the control module.

- Connecting terminal diagram:

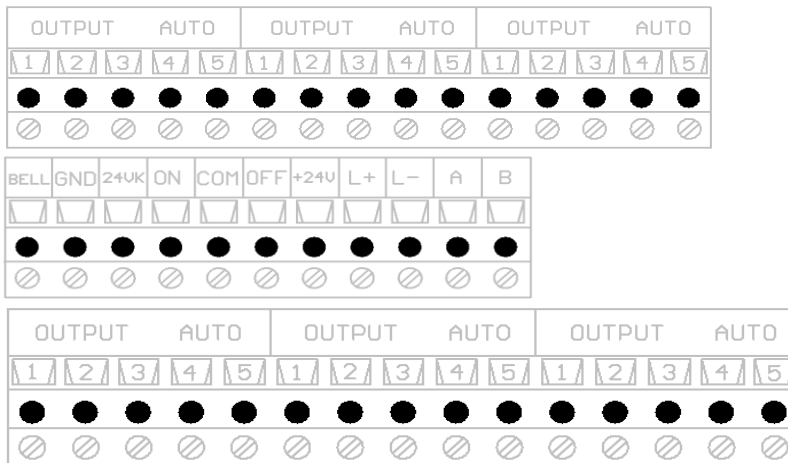

Notes:

- 1) The BELL terminal is used for bell drive output. When there is no fire alarm in the system, the BELL terminal will output 0V; when there is a fire alarm in the system, it will output +24V; and when the system is muted, it will stop outputting.
- 2) The 24VK terminal is a resetting the power and power up the equipment needing another power supply to recover from a power failure. When the system is recovering, the 24VK terminal will output 0V in a short time and the said equipment will be powered up again.
- 3) Terminals ON, COM and OFF are the three contacts of the relays. When the system is in normal operation, terminals COM and OFF are connected; and when the system has a fault, terminals COM and ON are connected. After the Reset key is pressed, terminals COM and ON will be disconnected.
- 4) Terminals L+ and L- are the two connecting terminals for the circuit bus.

- 5) Terminals A and B are the two communication data lines for display panels.
 6) Terminal +24V GND is a 24V output terminal for the power supply.
 7) Terminals OUTPUT AUTO are six groups of multi-line linkage output terminals (see §2-8 Operating instructions on multi-line linkage control).

● **Connecting terminals of the terminal board**

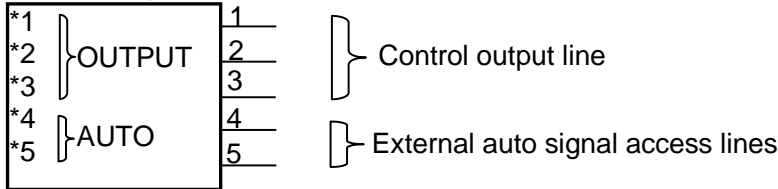

● **Connection terminals of load**



V. Main technical parameters

Major technical parameters of ATL-MN300 fire alarm control panel

- Capacity
ATL-MN300 system capacity: 324 points (non-polarity, two buses, fully mixed coding)
- AC input voltage: AC 220V±20% 50Hz
AC input power: 120W
- DC power: DC24V 5.0Ah, two fully sealed maintenance-free DC12V 5.0Ah storage batteries connected in series
The 24V DC power has a long-term constant output current of 6A.
The 5V DC power has a long-term constant output current of 4A.
- Circuit bus: two-wire system; total length: ≤1500m
- Voltage UL of the circuit bus:
+20V≤UL≤+26V (when the DC power is operating)
+24V≤UL≤+26V (when the AC power is operating)
- System working conditions
 1. Temperature: -10℃~+50℃
 2. Humidity: ≤95%
 3. Power supply:

AC	220V	50HZ	
DC	24V	6A	
 4. Output contact capacity:

AC	220V	1A
DC	27.6V	3A

See the specifications of detectors and modules for the specific technical parameters of the detectors, the interface module, the monitoring module and the control module.

VI. Precautions

1. **KEY ON/OFF:** The user needs to press **KEYBOARD** and input the correct password to operate the keyboard for setting the system and other equipment when the system is on the main interface and the keyboard is locked or when there is a FIRE or FAULT. There are three chances for password inputting.
2. **Save:** To save the changed data after an operation, press the # key. If the * key is pressed, the operation will be canceled, and the data will remain unchanged. If the system is restarted after a power failure before the changed data is saved, the unsaved data will be lost.
3. **Timeout Cancel:** If the system is waiting for the next click and no key is pressed within three minutes, the system will automatically cancel the whole operation, return to the main interface and lock the keyboard. At this time all the operations carried out in the period will be 'forgotten'.
4. **KEY OFF:** If it is found that the keyboard is unlocked after the system goes back to the main interface, the keyboard will be locked after the **KEYBOARD** is pressed. If no key is pressed within three minutes, the system will automatically return to the main interface and lock the keyboard.
5. **Address No.:** The address numbers are the physical codes of the detectors and modules. When they are configured on the control panel, the address number ranges from 001 to 324. The addressing of the detectors and modules may be done freely. It is not allowed to set two address numbers that are the same on a single circuit.
6. **Type:** The types of interface input may be selected through the ▲ and ▼ keys. The type of corresponding actual equipment refers to the type of the detector or module that is connected to it. For example, Ion stands for an ion smoke detector, Interface for an interface module, etc.
7. **Zone\Floor\Room No.:** The zone\floor\room numbers are coded by the user: a room number is a 3-digit figure (1~255); a zone number is a 2-digit figure (1~15); and a floor number is a 2-digit figure (-9~89) too. The zone\floor\room numbers are corresponding to the addresses composed of address numbers.
8. The zone\floor\room numbers are repeatable. **The zone\floor\room numbers are basic data for the system, and all the system configurations are based on the zone\floor\room numbers. Hence the zone\floor\room numbers must be carefully planned to avoid by all means midway changes.**
9. **Register:** "1" stands for connection and "0" for disconnection.
10. **It can be connected with a mini-printer.**
11. **It can be connected with some floor fire display panels.**
12. **Alarm Threshold:** This includes high sensitivity, medium sensitivity, and low sensitivity.
13. **Control Mode:** Impulse output will output one pulse; and constant output is a continuous output.
14. **System Alarm Linkage:** This refers to the linkage modules that may be triggered by any detector or module alarm in the entire system.
15. **Time Delay:** This refers to the module start-up time delay set in the linkage operation, which can set at 0 second, 5 seconds, 10 seconds, 30 seconds, 60 seconds, 90 seconds, 120 seconds or 150 seconds.
16. **Zone Alarm Linkage:** This refers to the linkage modules that may be triggered by any detector or manual alarm in a zone. At most 15 zones and 30 groups in all can be set.
17. **Floor Alarm Linkage:** This refers to the corresponding module action of the floor where a detector or module giving an alarm is.
18. **Updown floor:** Updown floor means that neighboring floors realize linkage. The 'floor' is defined by the user when setting modules and detectors, and it may correspond to the actual floor or not. "0" means that the cross-floor does not exist; and "1" means that cross-floor exists.
19. **Type Alarm Linkage:** This refers to the module actions triggered by the actions of a certain type of alarm points.
20. **Composite Alarm Linkage:** This refers to module actions that can only be triggered when two detectors or modules act simultaneously. The Group No. is coded by the user.
21. **Sounder:** This is used for controlling the bell and the fire radio system.
22. **Cancel:** This is mainly used to clear the linkage settings.
23. **Bus control keys:** Only when the Bus Manual Control Enabled/Disabled indicator is on and these keys are configured can these keys on the bus manual control panel work. There are 8 keys of this sort in all.

F189 ADDRESS WRITER

Front: (see the right figure)

Digitron: This is used for displaying decimal addresses.

Note: Function of increasing an address by 1 automatically: This function will work only after a coding is successfully done and the coded object shown on the LED is taken away from the coding base.

Top cover interface: (see the right figure)

No.1: JP1, interface port

No.2: 24V power interface (for powering up the buses)

No.3: 24VDC power adapter interface

No.4: This is a switch for selecting the old or new bus protocol. After it is pulled up, the new bus protocol is applicable; and when it is pulled down, the old bus protocol is applicable. During bus switching, the LED will respectively display "324" (new) and "199" (old).

No.5: This is a start/stop key when the control panel is powered up by batteries. Pressing it for about 1 second when the control panel is operating will make the control panel shut down.

Precautions:

1. If an external power supply is used, there will be no power switch and the control panel will be started after it is powered up; and when the batteries have insufficient electric quantity, the system will remind the user of it by making the buzzer sound once every 30s.
2. If no operations are done within one minute when batteries are used, the LED screen will go out. The LED will display again if a key is pressed within five minutes. If there are no operations during the period, automatic shutdown will occur.
3. It would be best to use an external power supply during coding or code reading toward the multi-wire PCB or multi-line modules.

Troubleshooting methods for common faults:

1. Why are there frequent error prompts during coding or code reading?

Please check if the switch for selecting the old or new bus protocol is correctly operated.

2. If batteries are used, the product will shut down immediately after it is started through the START key.

This is because of low voltage of the batteries. Please charge the batteries.

Attached list 1:

Equipment type	Shortening
Ion	LZ
Photoelectric	GD
Heat	WG
Infrared	HW
Combined	FH
I/O module	JK
Manual call point	SB
Temperature sensing cable	WL
Pressure	YL
Hydrant	XS
Water flow displayer	SZ
Agent	QT
Electromagnetic valve	CF
Gate valve	ZF
Air out valve	PF
Air out fan	PF1
Air valve	FF
Air in fan	SF
Air in valve	SF1
Fireproof valve	FF1
Fireproof door	FM
Sprinkler valve	LF
Generator	FD
Sprinkler electromotor	LB
Fire water electromotor	XB
City power exchange	QS
Elevator	DT
Roll door	JL
Air-condition	KT
Broadcast	GB
Sounder	YY
Back	FH
Horn/strobe	SG

Attached list 2:

Equipment type	Shortening
Ion smoke detector	LZ
Photoelectric smoke detector	GD
Heat detector	WG
Infrared smoke detector	HW
Combined detector	FH
Manual call point	SB
Hydrant call point	XS
I/O module	JK
Monitor module	JS
Control module	KZ
Monitor and control module	KZJ
Bus manual control module	ZX
Fireman control module	LD
Horn/strobe	SG
Horn	SG1
Beacon	SG2

